



SMB University: Selling Cisco SMB Foundation Solutions

Networking Fundamentals

Objectives

- **Describe the function and operation of a hub, a switch and a router**
- **Describe the function and operation of a firewall and a gateway**
- **Describe the function and operation of Layer 2 switching, Layer 3 switching, and routing**
- **Identify the layers of the OSI model**
- **Describe the functionality of LAN, MAN, and WAN networks**
- **Identify the possible media types for LAN and WAN connections**

What is a Network?

- A network refers to two or more connected computers that can share resources such as data, a printer, an Internet connection, applications, or a combination of these resources.

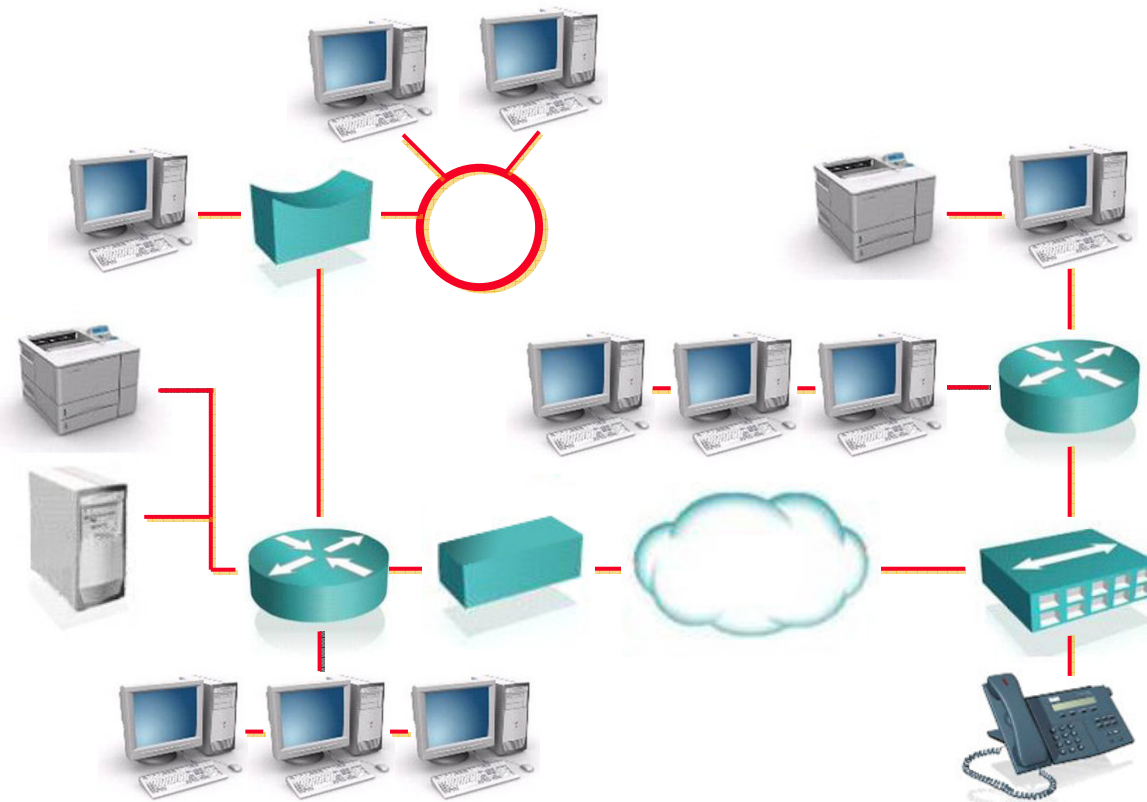

Types of Networks

Local Area Network (LAN)

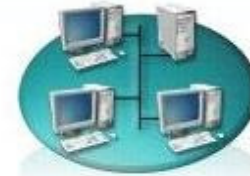

Metropolitan Area Network (MAN)

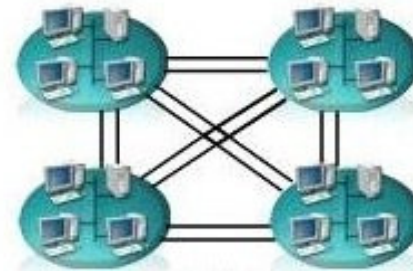

Wide Area Network (WAN)



WAN Technologies

Leased Line

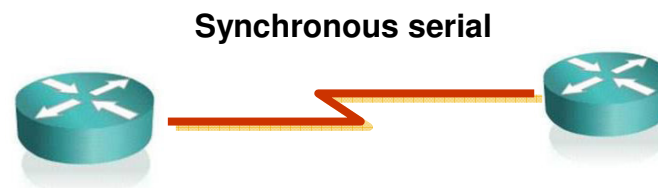

Circuit-switched

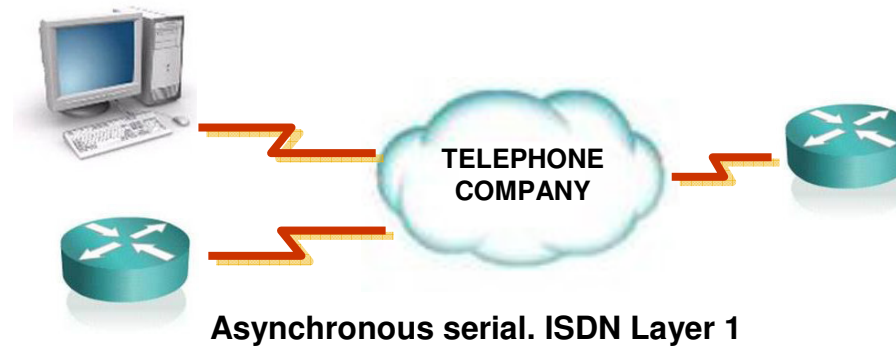

WAN Technologies (Cont.)

Frame-Relay

Synchronous serial



Broadband Access



Network Topologies: Bus Topology



Network Topologies: Star Topology

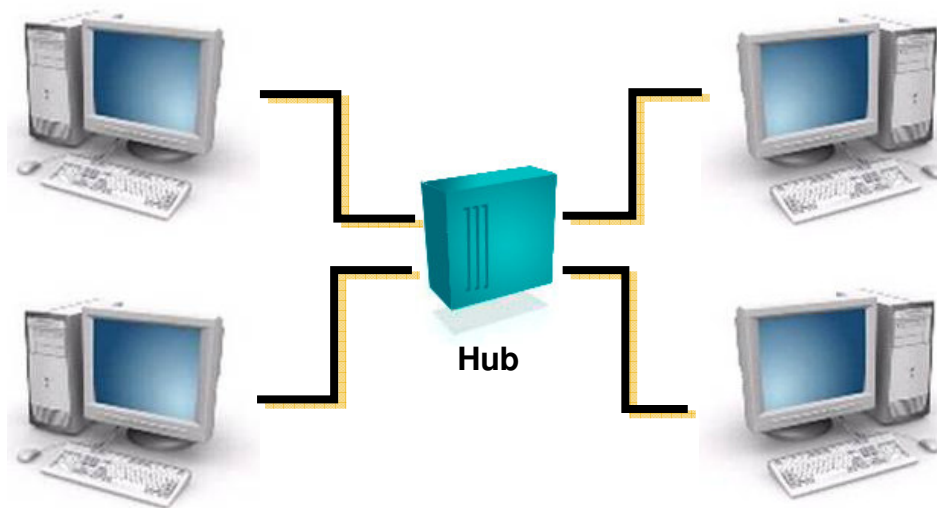

Network Topologies: Extended Star Topology

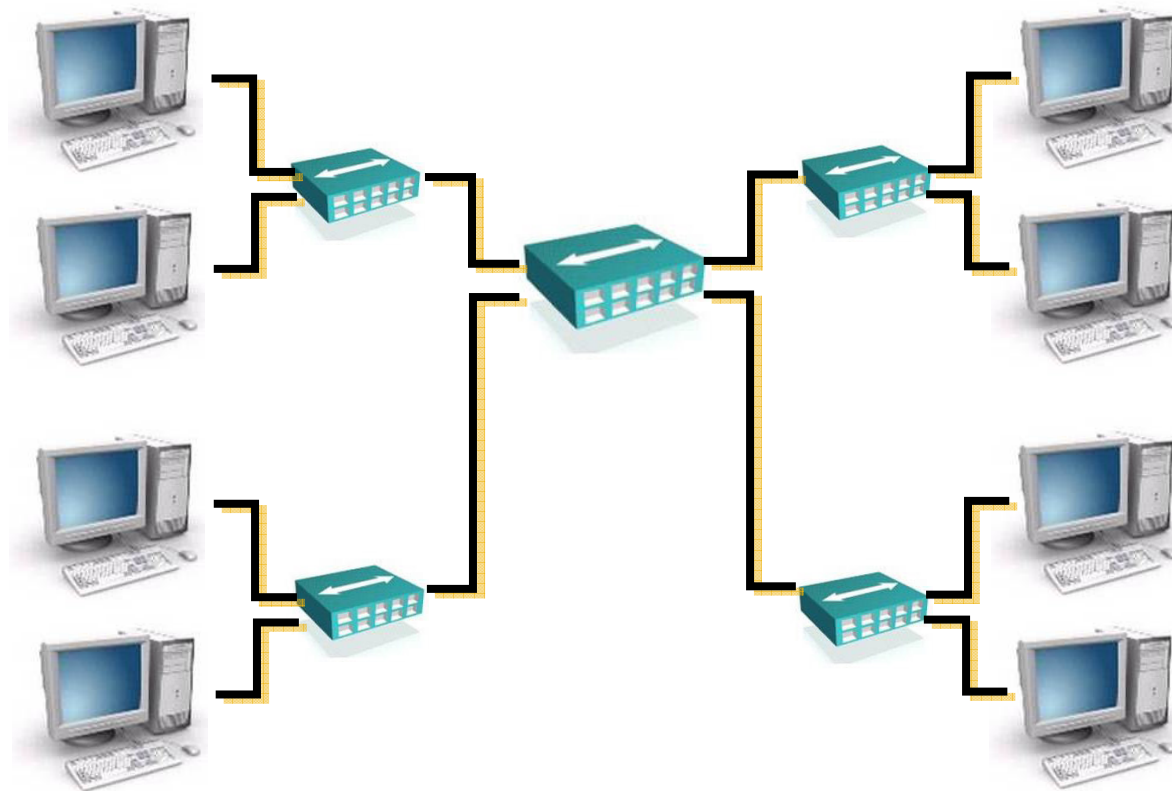

The OSI Model— Why a Layered Network Model?

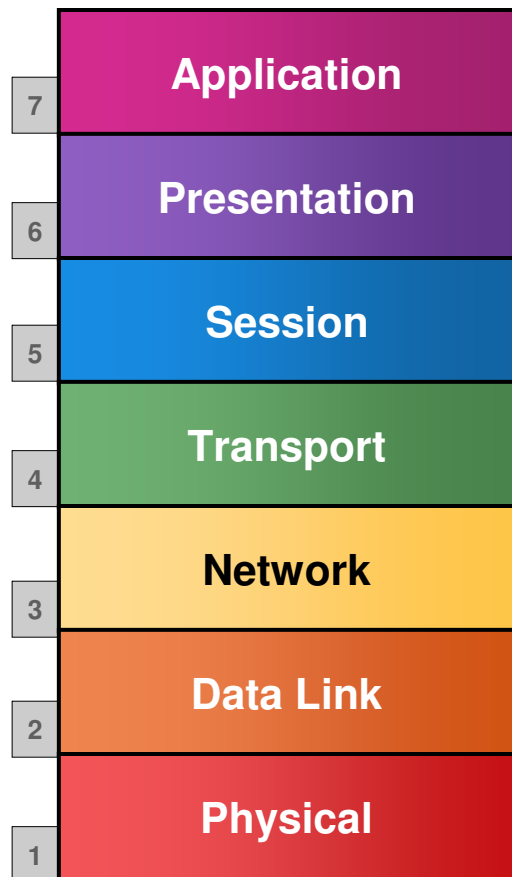

- **Reduces complexity**
- **Standardizes interfaces**
- **Facilitates modular engineering**
- **Ensures interoperable technology**
- **Accelerates evolution**
- **Simplifies teaching and learning**

The Seven Layers of the OSI Model

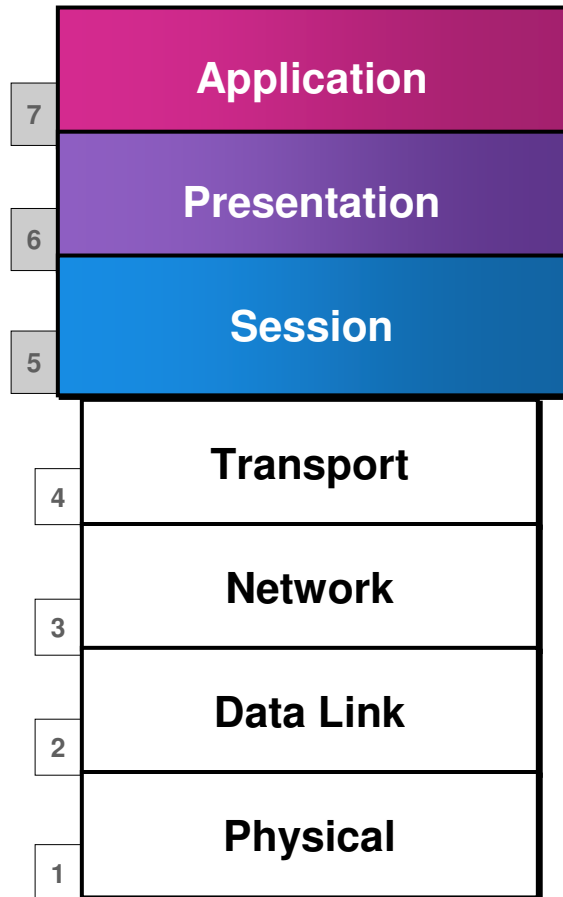

Application Layers (Upper Layers):

- Network Processes to Applications
- Data Representation
- InterHost Communication

The Seven Layers of the OSI Model (Cont.)

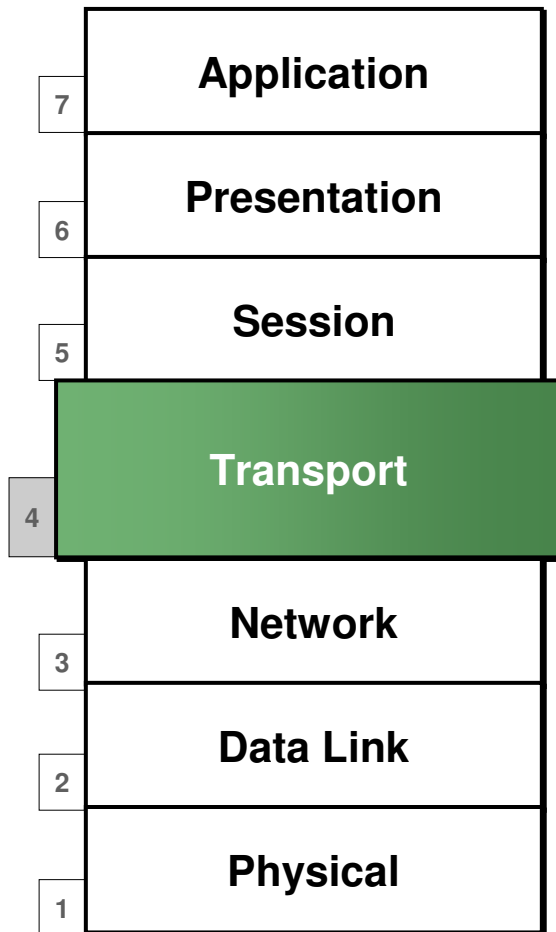

End To End Connections:

- Handles transportation issues between hosts
- Ensures data transport reliability
- Establishes, maintains and terminates virtual circuits
- Provides reliability through fault detection and recovery
- Information flow control

The Seven Layers of the OSI Model (Cont.)

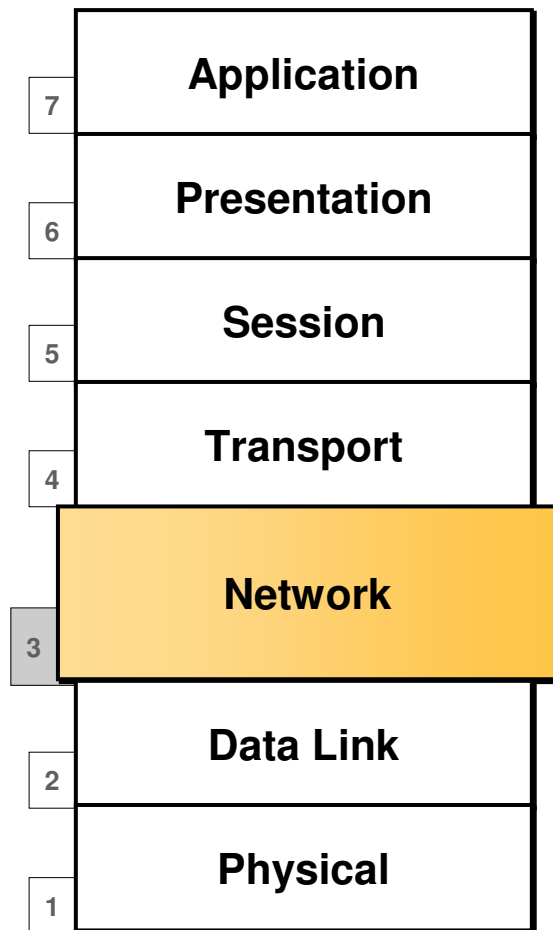

Data Delivery:

- Provides connectivity and path selection between two host systems
- Routes data packets
- Selects best path to deliver data
- The Network layer prioritizes data known as Quality of Service (QoS)

The Seven Layers of the OSI Model (Cont.)

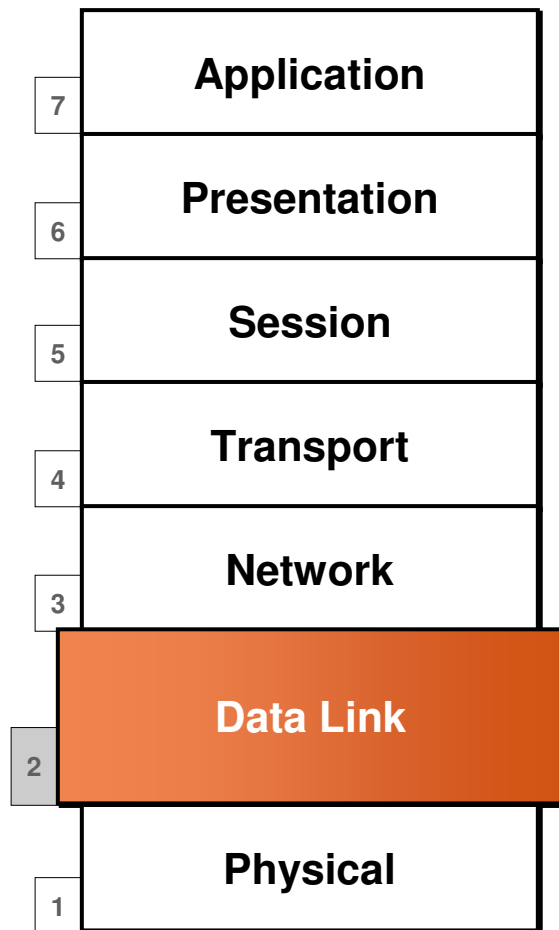

Access to Media:

- Defines how data is formatted for transmission and how access to the network is controlled

The Seven Layers of the OSI Model (Cont.)

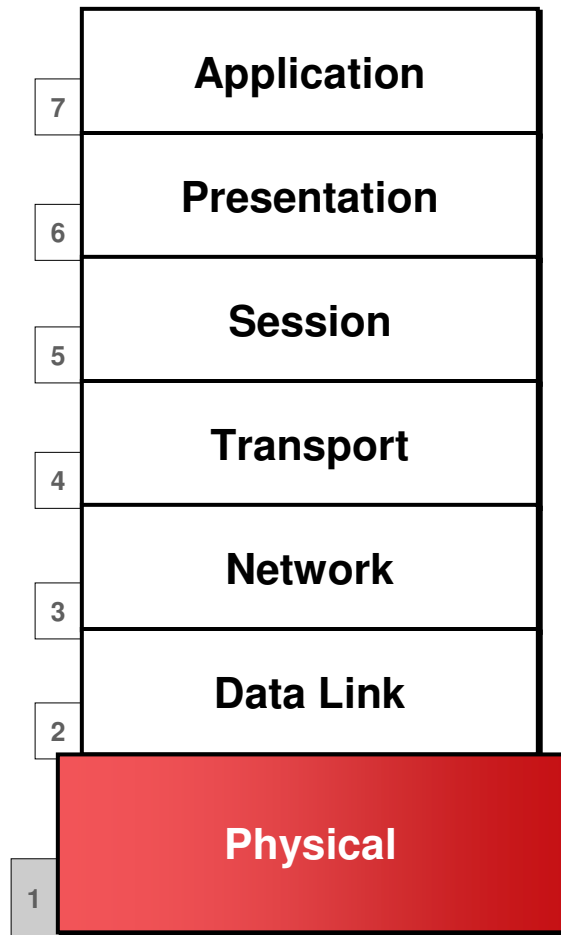

Binary Transmission:

- Defines the electrical, mechanical, procedural, and functional specifications for activating, maintaining, and deactivating the physical link

Physical Media Types

Twisted-Pair

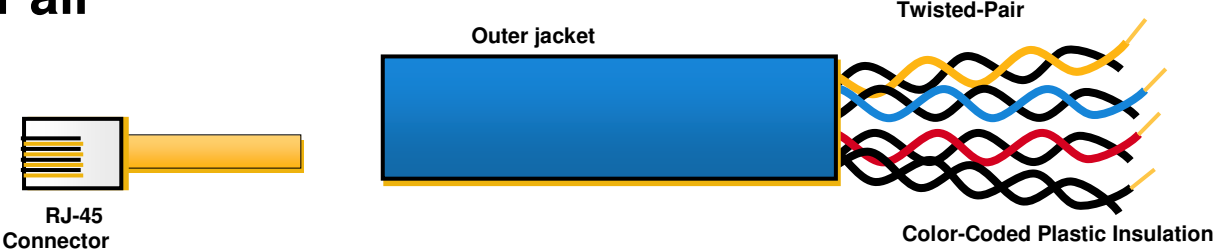

Coaxial



Fiber Optics



Physical Media Types (Cont.)

Wireless

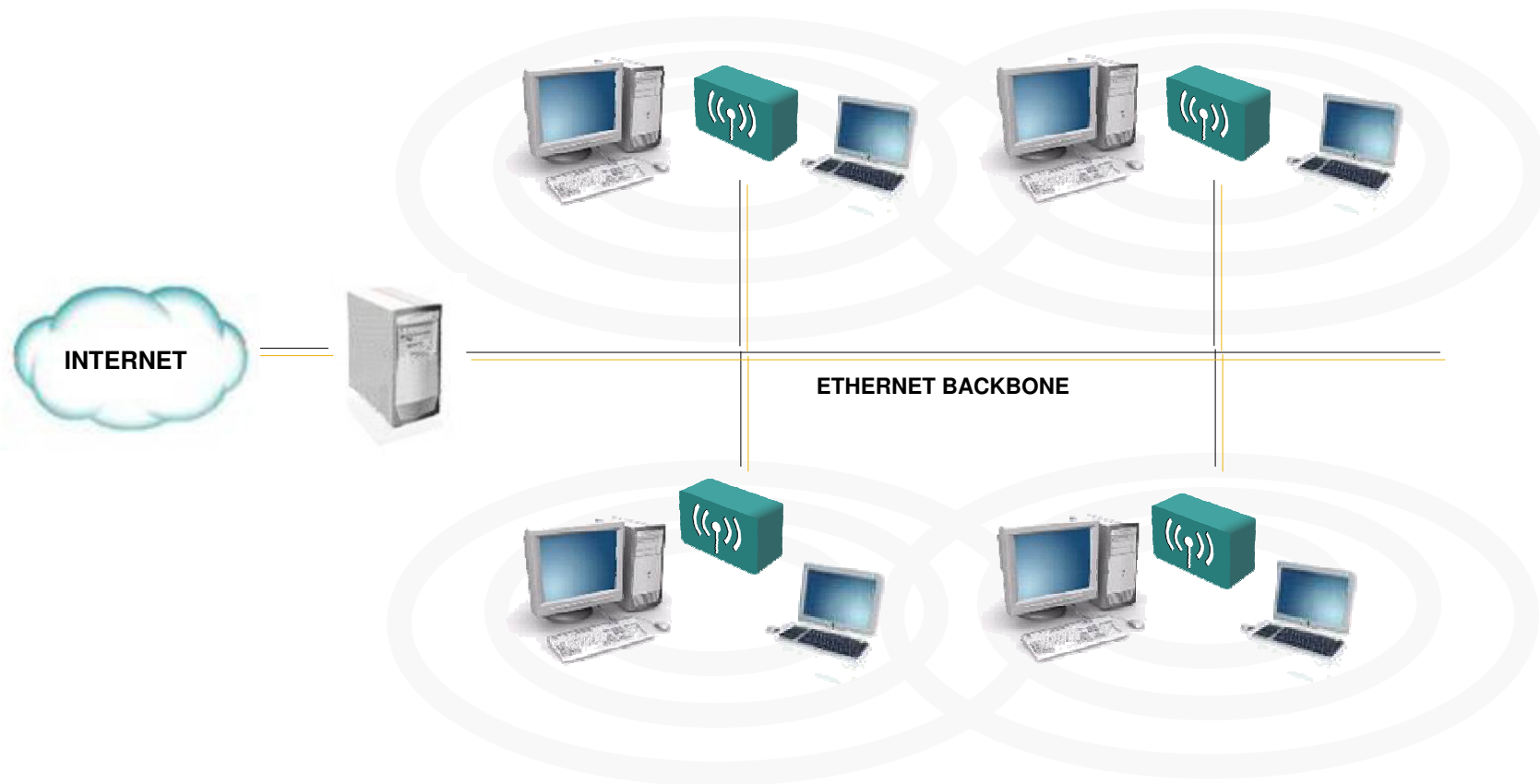

Physical Media Comparison

	Twisted Pair	Coaxial	Fiber Optic	Wireless LAN
Bandwidth	Up to 1 Gbps	10–100 Mbps	Up to 10 Gbps or higher	Up to 54 Mbps
Distance	Up to 100 m	Up to 500 m	Up to 60 km	Up to 100 m
Price	Least expensive	Inexpensive	Most expensive	Moderate

Hub or Repeater

- A hub (concentrator) is a device that repeats the signals it receives on one port to all other ports. It is a central connection point for several network devices.

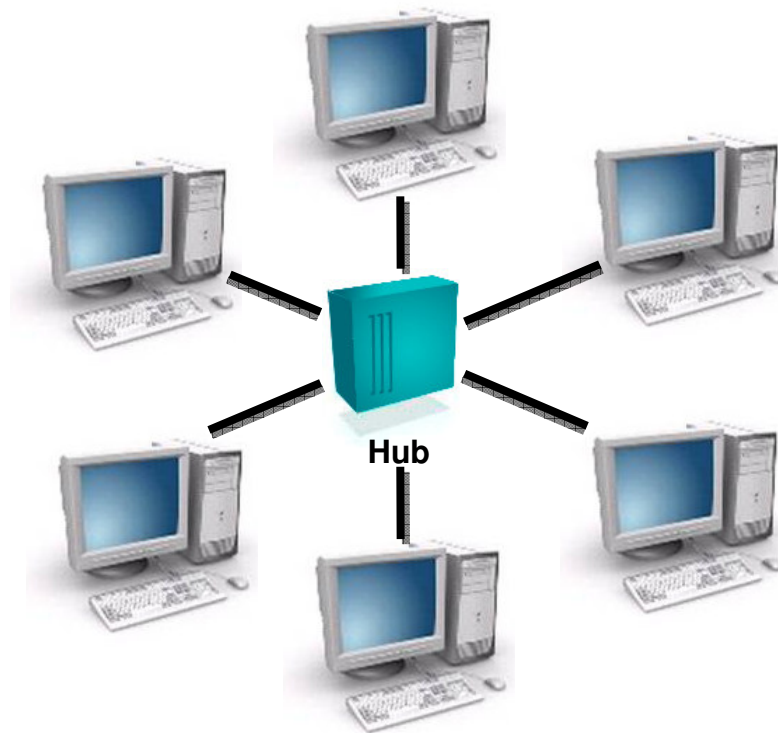

Hub (Multiport Repeater)

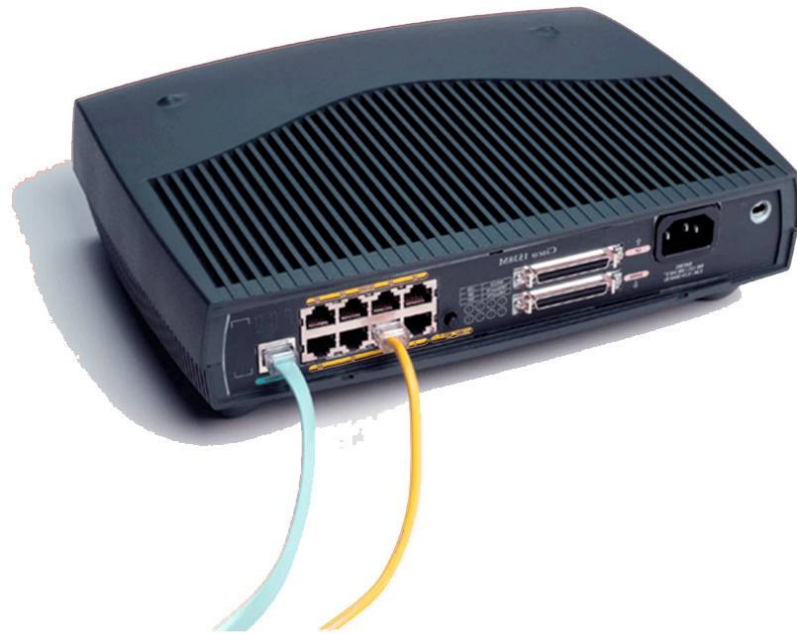

Network Interface Card

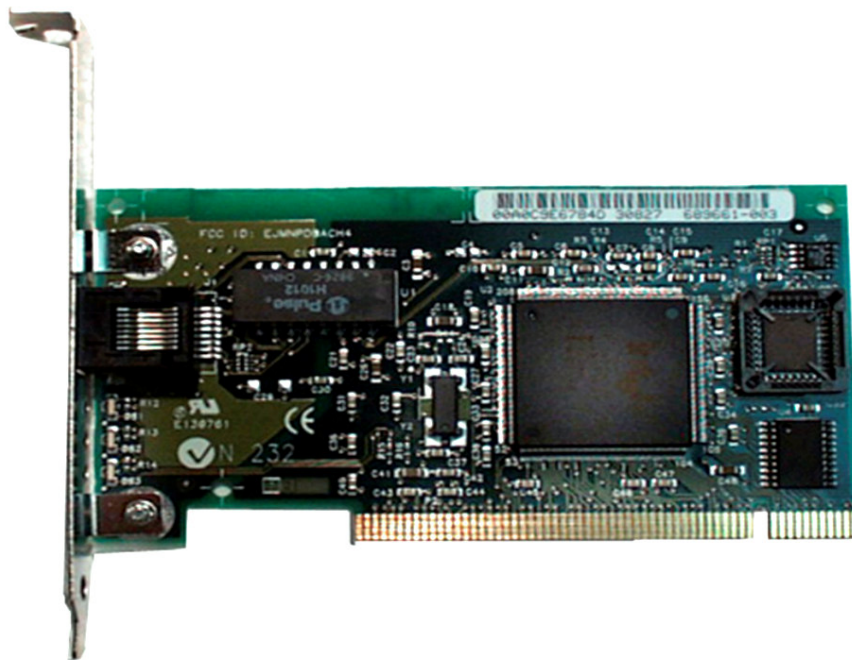

WAN—Physical Layer Implementations

- Physical layer implementations vary
- Cable specifications define speed of link

Cisco HDLC	PPP	Frame Relay	ISDN BRI (with PPP)	DSL Modem	Cable Modem
EIA/TIA-232 EIA/TIA-449 X.21 V.24 V.35 HSSI			RJ-48 Note: ISDN BRI cable pinouts are different than the pinouts for Ethernet. The RJ-48 and RJ-45 look the same, but the pinouts are different.	RJ-11 Note: Works over telephone line	BNC Note: Works over Cable TV line

WAN

Physical Media

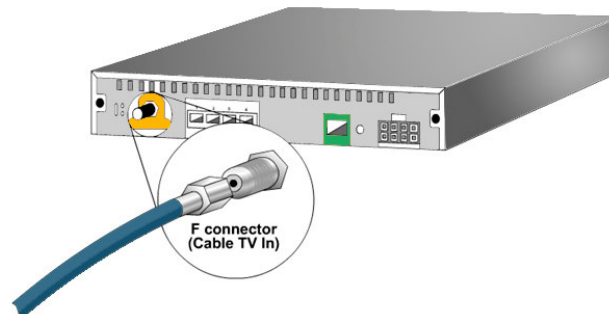
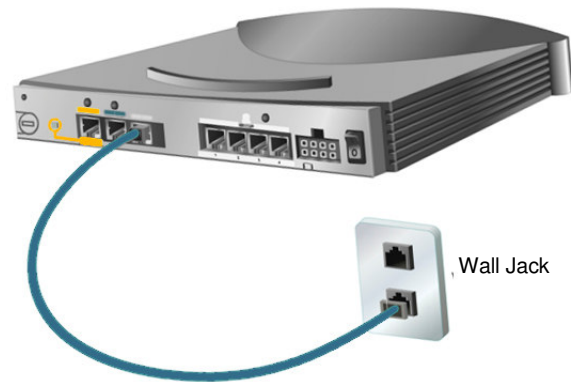

Data Link Layer

- **Data Link layer protocols create, transmit, and receive packets. This layer is also responsible for logical MAC addressing and LLC processing, creating logical topologies, and controlling media access.**



MAC Address

- The network interface card address, called the hardware address, is protocol-independent and is usually assigned at the factory. This address is technically called the media access control address (MAC) because it is found on the MAC sub layer of the Data Link layer.

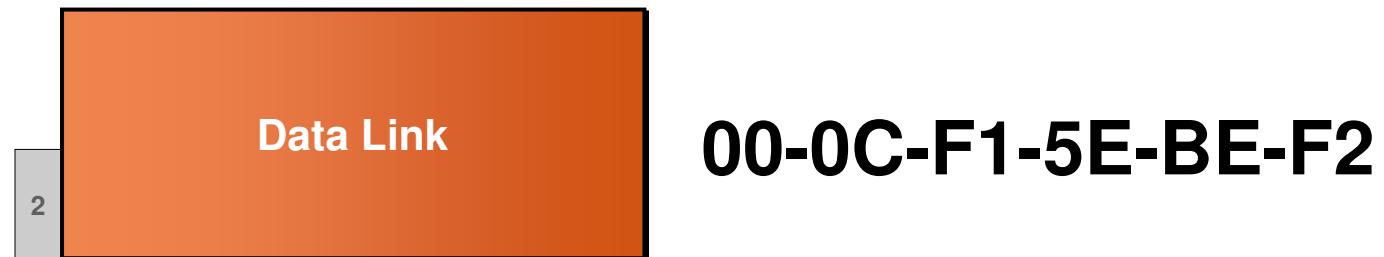

MAC Address = Hardware Address

Data Link Devices

- **The Data Link layer is manipulated by two devices: bridges and switches. These are more complex and more expensive than their Physical layer counterparts, but they do have advantages.**

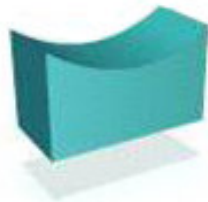

Bridges



Switches

Switch

- When a switch receives data the switch examines the data link header for the MAC address of the destination station and forwards it to the correct port. This opens a path between ports that can use the full bandwidth of the topology.

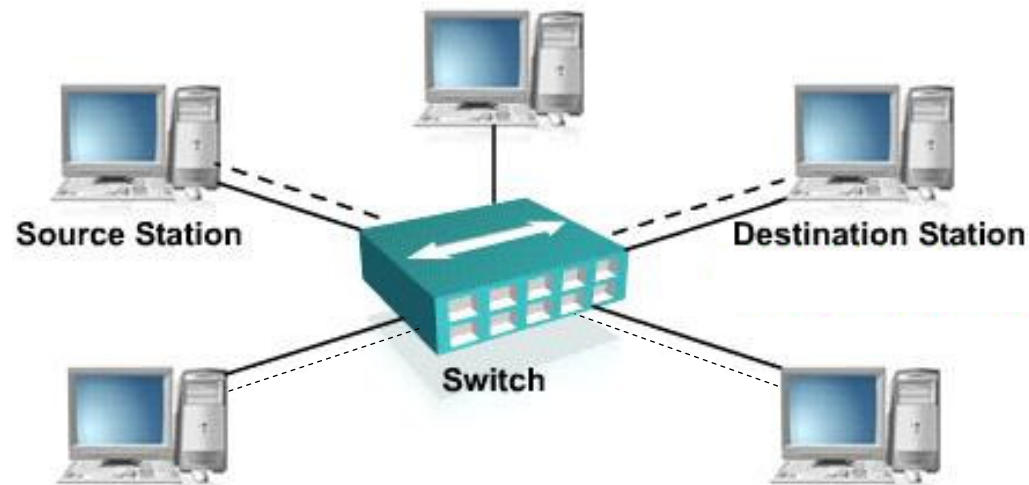

Network Layer

- **The network layer provides connectivity and path selection between two host systems that may be located on geographically separated networks**



Network Layer (Cont.)

- **IP is a standard that defines the manner in which the network layers of two hosts interact. IP addresses are 32 bit long, hierarchical addressing scheme.**



IP Address = Logical Address

Network Layer Devices

- The devices that operate at the Network layer are routers and Layer 3 Switches



Router



Layer 3 Switch

Routers

- **Routers facilitate communication within this internet work. It decides how to send packets within the network so that they arrive at their destination.**

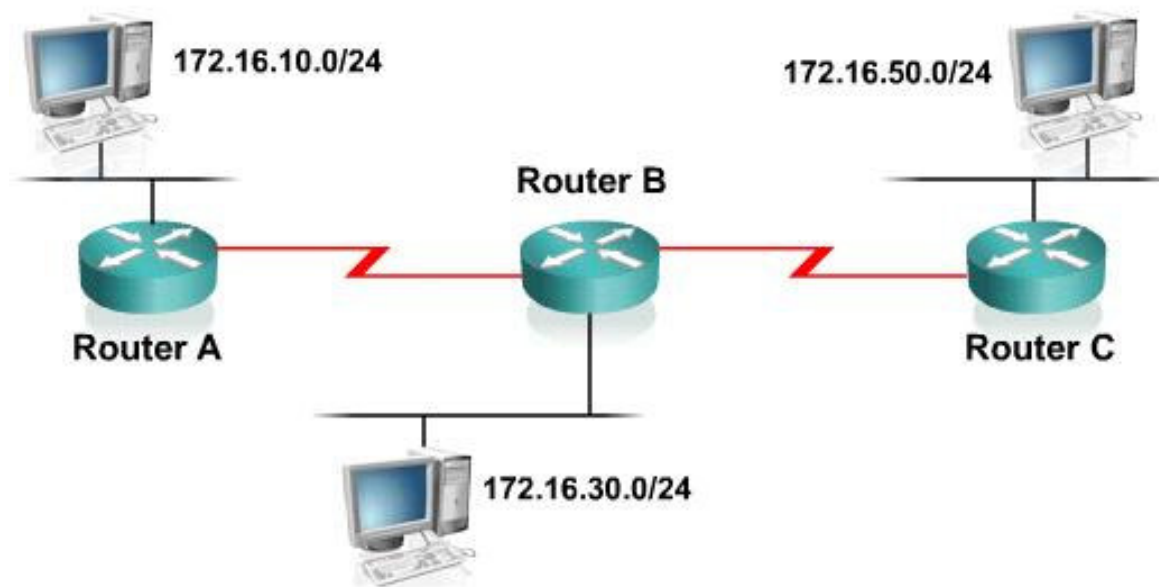

Layer 3 Switches

- The Layer 3 switch functions at the Network layer and performs the multiport, virtual LAN, data pipelining functions of a standard Layer 2 switch. It can also perform basic routing functions between virtual LANs.

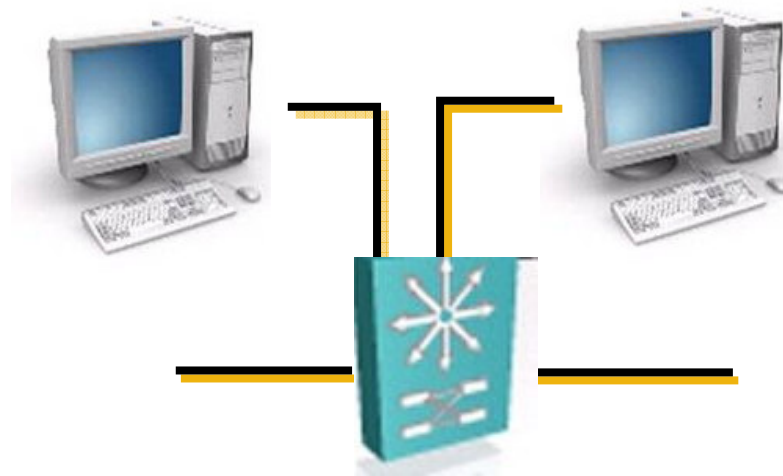

Layer 3 Switch

Multilayer Switching

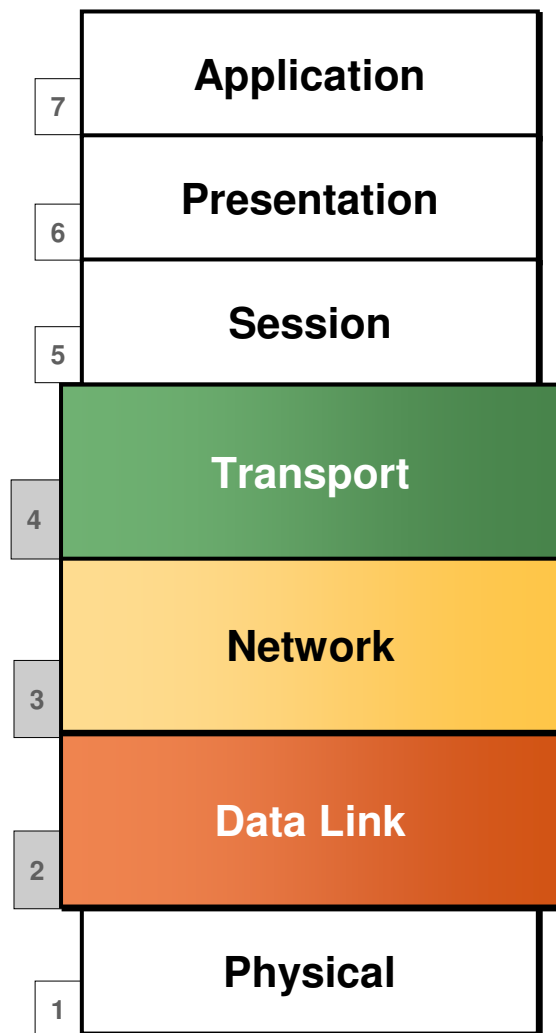

- **Combines functionality of:**
 - Layer 2 switching
 - Layer 3 switching
 - Layer 4 switching
- **High-speed scalability**
- **Low latency compared to routers**

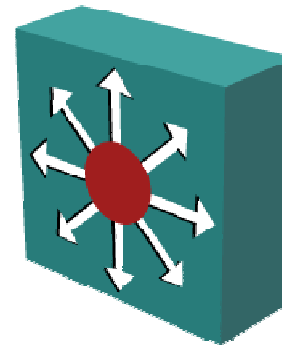

Transport Layer Implementations

- The Transport layer is charge of the reliable/unreliable transport of data. It can be implemented as TCP or UDP.



Gateway

- A gateway is a combination of hardware and software that connects dissimilar network environments. It performs translations at multiple layers of the open system interconnection (OSI) model.

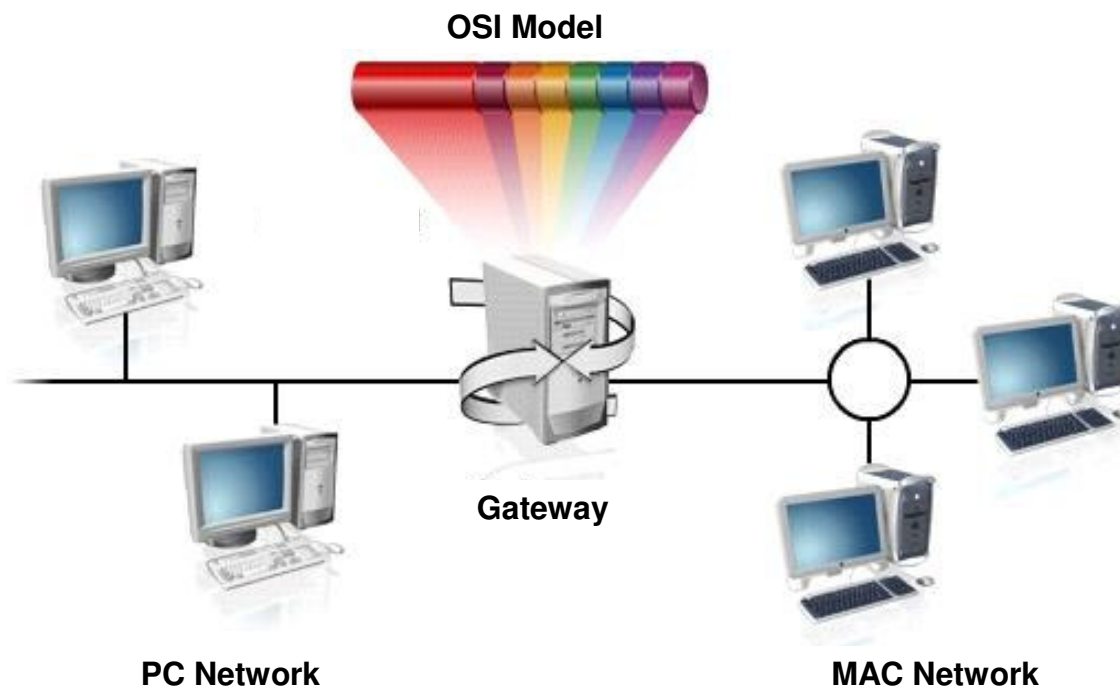

Firewalls

- A firewall is a system or group of systems that manages access between two or more networks

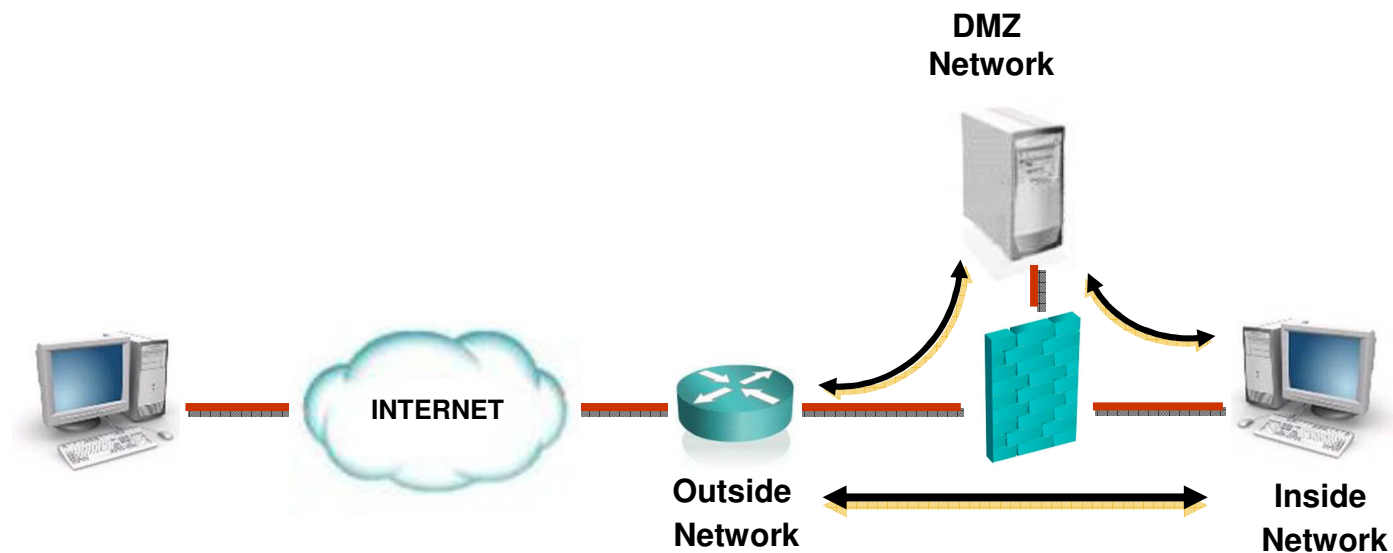

Summary

This lesson covered the following main topics:

- **The function and operation of a hub, a switch, and a router**
- **The function and operation of Layer 2 switching, Layer 3 switching, and routing**
- **The OSI model**
- **Functionality of LAN, MAN and WAN networks**
- **Possible media types for LAN and WAN connections**
- **The function and definition of firewalls and gateways**



CISCO